

CS-Pro VET

HANDHELD FOCUSED EXTRACORPOREAL
SHOCK WAVE DEVICE
(Black Standoff)

USER MANUAL AND SPECIFICATION

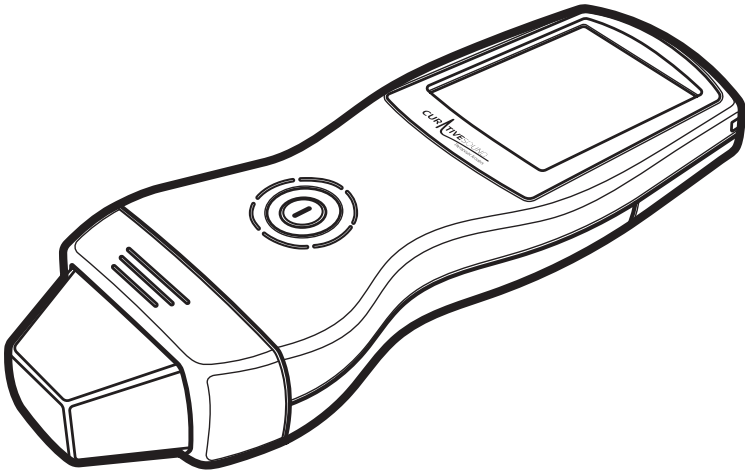

SYSTEM COMPONENTS:

- Carrying Case
- CS-Pro VET Handheld Unit
- Standoffs (2, 5, 10, 20 and 30mm)
- Li-ion Battery (2 pcs)
- Ultrasound Gel (1 Bottle)
- Battery Charger
- Charger Power Supply
- Transducer Array Couplant Oil
- Wrist Strap
- Shoulder Strap



Curative Sound, LLC.
11611 N. Meridian Street, Suite 425
Carmel, IN 46032 USA

INTRODUCTION:

The CS-Pro VET is a state-of-the-art, portable handheld device that produces high-pressure, focused, acoustic shock waves. It was designed to provide health care professionals an effective and easy-to-use device for administering the latest and most advanced focused Extracorporeal Shock Wave Therapy (ESWT) treatment to equine and smaller companion animal patients. Focused ESWT is an evidence-based therapy used across multiple orthopedic and wound healing indications. Focused acoustic shock waves trigger a biological healing response in tissue by the shear and pressure forces they produce.

DEVICE KIT:

A robust carrying case (1) contains the CS-Pro VET device (2), and five standoffs (3) used to change the focal depth of the shock wave energy in tissue. It also contains two rechargeable Li-ion batteries (4), a charger (5), and a charger power supply (6). A squeeze bottle (7) contains a special couplant oil which is applied between the standoff and transducer array to ensure the optimal transfer of shock wave energy from the device transducer array through the standoff. (Additionally, water-based ultrasound gel must also be applied to the treatment area to ensure the transfer of shock wave energy into the tissue.) A wrist strap (8) can be used to prevent accidental dropping of the device during use. A shoulder strap for the case is also provided (not shown).

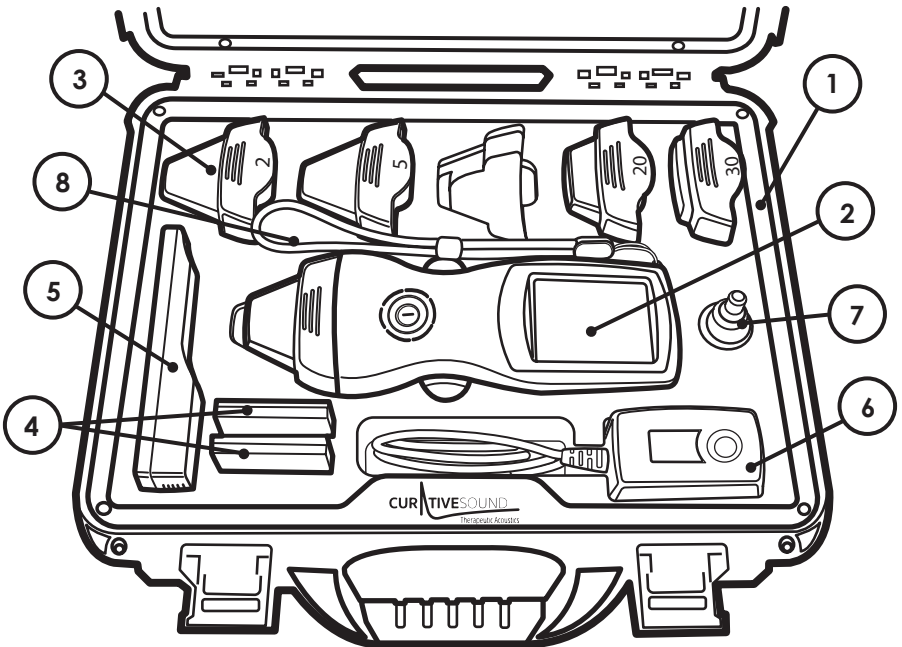

USER INTERFACE:

The CS-Pro VET device is simple and easy to operate. The user interface consists of a large, round tactile button (9) surrounded by an LED light ring (10). The button has multiple functions. Pressing and holding the button for 3 seconds powers the device on. During this step, the LED's will slowly rotate, and the Curative Sound logo will appear on the display. Once the device is powered on, a momentary "press and release" of the button will start or stop the generation of shock waves. The light ring and display are continuously illuminated when the device is powered on. The LED's rotate at the pulse repetition frequency when shock waves are being generated, and an audible clicking will be heard.

The CS-Pro VET device also features a 2.8" color touch screen display (11). Soft buttons on the display are used to change energy levels, set and reset the number of shock waves to be administered, and change the pulse repetition frequency. Information such as the number of shock waves generated and the focal depth of the shock wave energy in tissue is also shown on the display. Once powered on, pressing and holding the button for 3 seconds will produce a power-off confirmation on the display, with a soft button that can be used to power off the device.

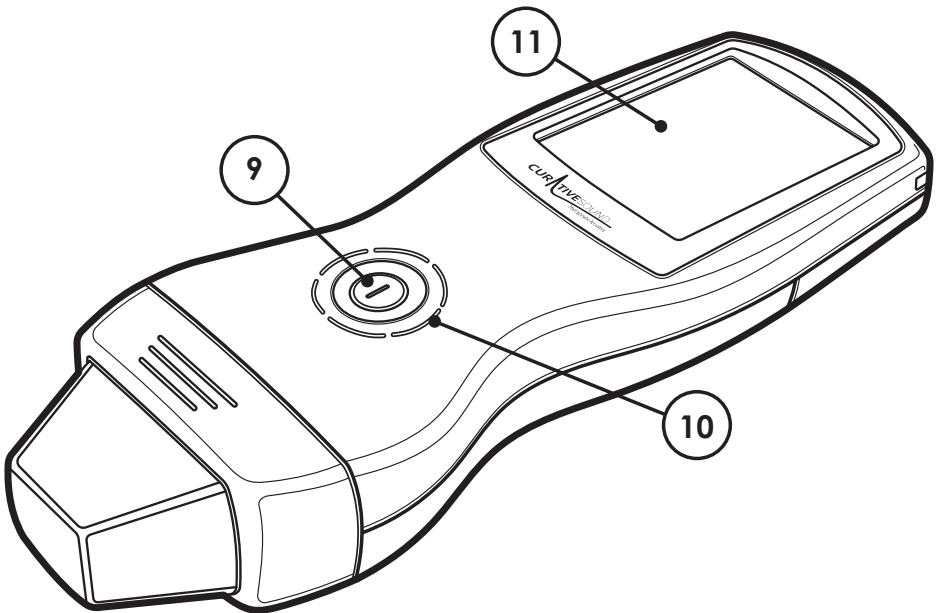

DEVICE OPERATION:

Remove the CS-Pro VET device from the case.

- A. Open the battery door (12) and install a fully charged battery.
- B. From the case, select the standoff with the focal depth that is specified by the therapy protocol. Note that the focal depth is shown on the back of each standoff (13) in millimeters.

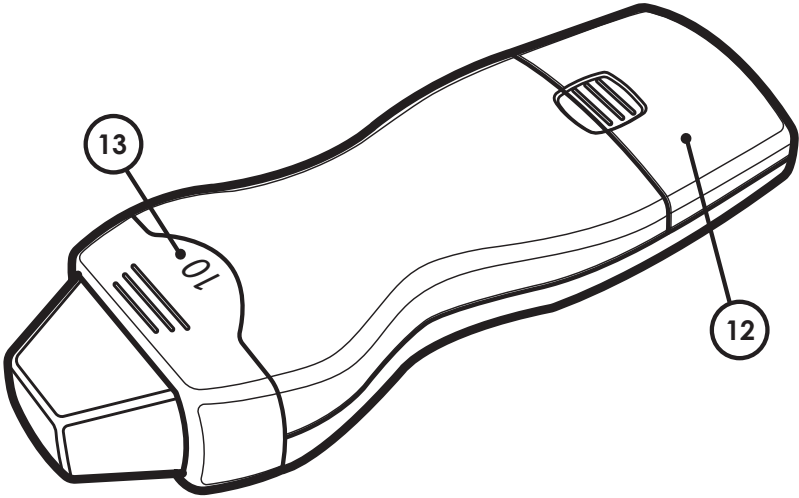

- C. Remove the dust cover (14) from the standoff and store it in the case. Note that the purpose of the dust cover is to keep the surface of the standoff that contacts the transducer array clean and free from dust and debris.

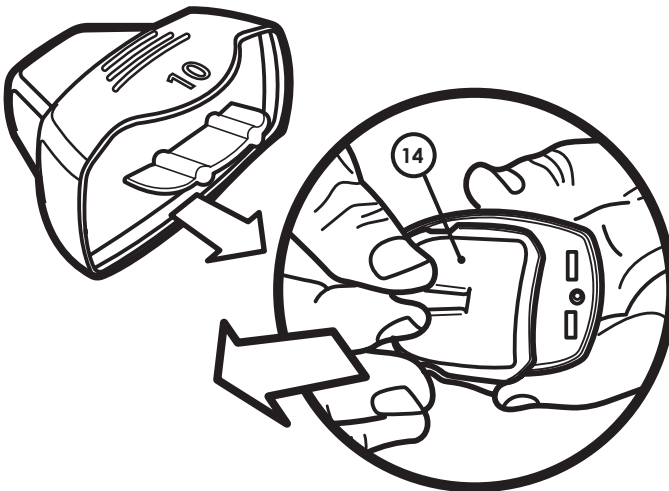

- D. To transfer shock wave energy internally from the transducer array to the standoff, a thin film of transducer array couplant oil must be present between those two surfaces. If the device has sat dormant for more than 3 days or when the standoff is being changed, check to make sure the smooth concave surface of the transducer array appears wet and shiny. If not, carefully apply and spread a drop of couplant oil to the array surface as shown with a lint free cloth or a clean fingertip. Additionally, whenever the standoff is removed from the device, wipe off any excess oil that has settled onto the plastic walls of the standoff. This will keep couplant oil from getting on other surfaces of the device or inside of the carrying case.

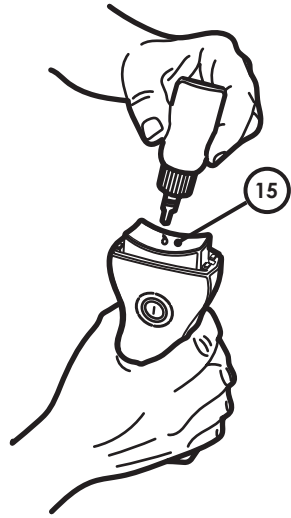

- E. To **"Power On"** the device, press and hold the tactile button for 3 seconds until the start up sequence is completed and the LED light ring and display become illuminated.
- F. The installed standoff will automatically be identified by the device electronics, and the focal depth will be shown on the display (16). This is the same number shown on the back of the standoff. **Check to ensure that the focal depth is correct for the protocol that is going to be administered.**

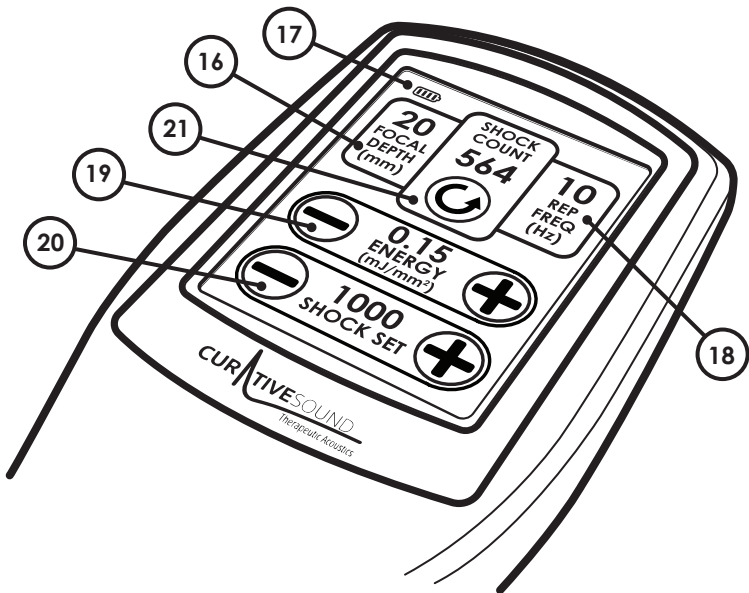

- G. Check the battery charge level (17) shown on the display. Change the battery if necessary. A fully charged battery should power the device for at least 20 typical therapy sessions over the course of about 4 hours.
- H. The pulse repetition frequency (18) can be varied depending on the protocol and can be changed by pressing the "REP FREQ" soft button on the display. A screen with "+" and "-" soft buttons will appear that can be used to change the pulse repetition frequency between 2 to 12 Hz. 10 Hz is commonly used in many protocols.
- I. Set the energy flux density (mJ/mm^2) as specified in the protocol using the "ENERGY" soft button (19) on the display. (See additional discussion below.)
- J. Set the number of shock waves to be delivered to a treatment area using the "SHOCK SET" soft button (20) on the display.

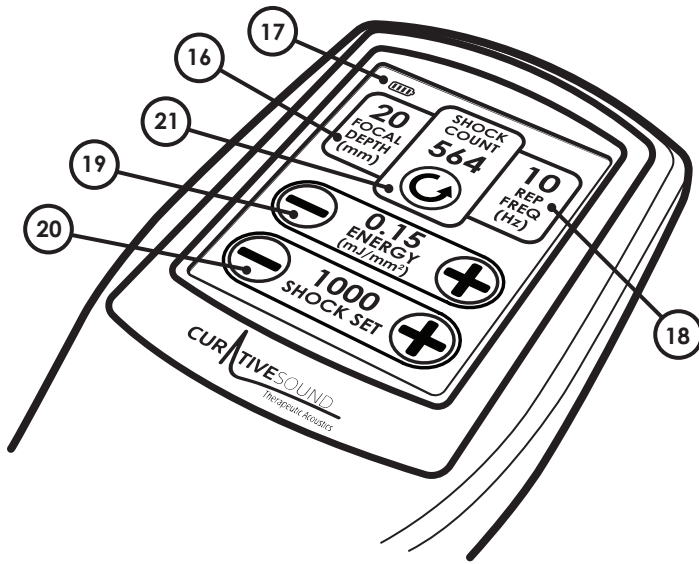

- K. Apply a water-based ultrasound gel liberally to the skin on the area to be treated. Place the end of the standoff perpendicularly against the skin on the area to be treated. Start the generation of shock waves with a momentary press of the tactile button. Apply shock waves by moving the standoff against the skin with gentle pressure using a slow, circular motion. Shock waves will be generated until the counter "SHOCK COUNT" equals "SHOCK SET", or until the clinician presses the tactile button. At the point where "SHOCK COUNT" equals "SHOCK SET" and the device stops, the clinician can press the reset button (21) on the display or press the round tactile button (9) to change "SHOCK COUNT" back to zero and move to another treatment area to repeat the process or conclude the treatment.

- L. Power down the device by pressing and holding the tactile button for 3 seconds. Complete this action by pressing the confirmation soft button on the display **(22)**. Note that the total number of shock waves, firmware revision level, and device serial number are displayed on the screen before power down.
- M. Wipe off the contact areas of the standoff and the product housing to remove any remaining ultrasound gel (see cleaning instructions below), and place the device back into the carrying case. The standoff can be left on the device or removed and placed in the case with the dust cover reinstalled. The battery should be removed if the device is to be stored for an extended period of time.

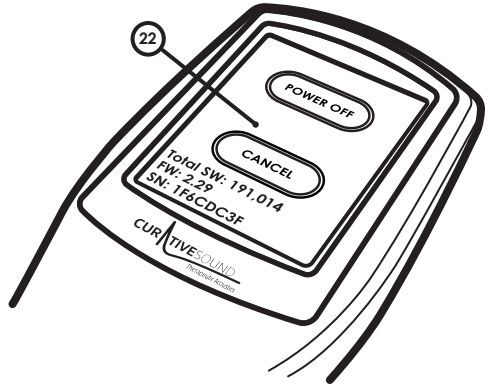

Additional Information:



Caution

- Never apply petroleum-based products as a couplant oil on the standoff. It will damage the standoff polymer and void the warranty.
- Hold the device perpendicular to the skin and use plenty of ultrasound gel during treatment. Therapeutic shock wave energy will not travel through air or air bubbles. Fur at the treatment area should be shaved if it is long or thick to make more reliable contact with the skin.
- Do not leave the device in a hot vehicle for extended periods of time.
- Do not expose the device to excessive water.
- Use the hand strap to avoid dropping the device. The housing may become slippery if ultrasound gel gets on the grip surfaces.



Warning

- The device is for use by or under the supervision of a licensed veterinarian.
- NEVER open the housing of the CS-Pro VET. The device contains high voltage components that could cause serious injury. Never use the device if the housing is damaged and exposing any of the electronics.

- **IMPORTANT!** The standoff is attached with strong neodymium magnets and should be kept a safe and long distance away from individuals with a pacemaker or an implanted heart defibrillator.
- The CS-Pro VET is equipped with two 8.5Wh lithium-ion batteries. It is important to note that lithium-ion batteries may pose a risk of fire or explosion if they are damaged or not used properly. Rechargeable lithium cells can be dangerous for consumers without proper safety measures. Do not heat them above 80°C. Always use the supplied battery charger. Before traveling, remove the batteries from the device and store them securely in their designated location in the carrying case. Additionally, before flying, check the airline's policy regarding lithium-ion batteries.
- ESWT is known to have an analgesic effect for up to 4 days after treatment. Care should be taken to ensure that the underlying musculoskeletal disorder has improved before allowing increased physical activity.
- ESWT is known for a low incidence of side effects, however some bruising may occur. ESWT from the CS-ProVET device is painless on thick tissue areas but can cause discomfort on inflamed joints at higher energy settings.

Contraindications for Focused ESWT:

Focused ESWT is known to be safe and effective with a very low incidence of side effects. However, there are instances where ESWT should NOT be used:

- Malignant tumor in the treatment area (not as underlying disease)
- Fetus in the treatment area
- Epiphyseal plate in the treatment area
- Brain or spine in the treatment area
- Heart and lung tissue in the treatment area
- Eyes or ears in the treatment area
- Severe coagulopathy or use of blood thinner medication

Charging the Battery:

Place the charger on a flat, level surface away from sources of heat and moisture. Plug the DC connector from the power supply into the rear of the charger, and plug the other end of the cord into an AC power outlet. A green LED will be illuminated on the charger.

Slide the battery into the charger so that the electrical contacts on the battery mate fully with the electrical contacts on the charger. The green LED will change to amber indicating that the battery is charging. Once the battery is fully charged, the amber LED will change back to green.

The charging time for a fully discharged battery is approximately 4 hours. If the LED becomes red, a fault condition has occurred. Ensure that the charger has not overheated due to being covered or placed in direct sunlight. If so, let the charger cool and try again. If problems continue to persist, contact the manufacturer at **service@curative-sound.com**.

Couplant Oil Applied between the Standoff and the Array Transducer:

Couplant oil is used to ensure that energy created by the transducer array is transferred through the standoff. A thin film of couplant oil between the transducer array and standoff displaces air and avoids a reflection that could reduce output. The couplant oil supplied with the device is not petroleum based and has high purity and optimal viscosity. It is non-evaporative and generally only needs to be re-applied if the standoffs are changed frequently. The use of petroleum-based oil will damage the standoff material and void the warranty. Also, the use of water-based couplant between the transducer array and the standoff will not adhere to the standoff resulting in reduced output.

Ultrasound Gel Applied on the Treatment Area:

A water-based ultrasound gel must be applied liberally to the skin at the treatment area. These gels are readily available on Amazon or from the manufacturer themselves, e.g. Parker Labs Aquasonic Clear Ultrasound Gel (www.parkerlabs.com). The gel displaces air between the contact end of the standoff and the skin, avoiding reflections that could reduce the therapeutic energy transferred into the tissue. The gel also allows the standoff to be maneuvered easily over the treatment area. It is recommended that fur be shaved at the treatment site for animals with long or thick coats.

Energy Flux Density versus Standoff:

Some loss of energy occurs as the shock wave travels through the standoff polymer, so higher energy flux densities can be produced with the shorter standoffs. The device has 6 different energy settings, and the energy flux density shown on the display depends on the standoff that is installed and automatically detected on the device. For a given installed standoff, the available energy flux density settings will be available on the display. They correspond to the settings shown in Table 1 below:

Table 1. Energy Flux Density (mJ/mm²) versus energy setting for each standoff

ENERGY	STANDOFF				
	2mm	5mm	10mm	20mm	30mm
Level 1	0.03	0.02	0.02	0.03	0.04
Level 2	0.07	0.06	0.05	0.06	0.07
Level 3	0.10	0.09	0.08	0.08	0.09
Level 4	0.14	0.13	0.12	0.12	0.14
Level 5	0.16	0.15	0.14	0.15	0.17
Level 6	0.20	0.19	0.18	0.19	0.22

Additional Displayed User Information and Fault Codes:

In certain instances, additional information may also be displayed:

User Information:

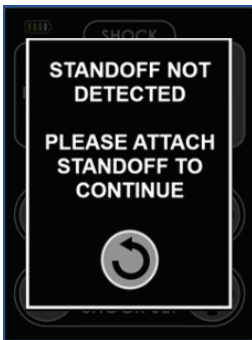

Standoff Missing

Message presented when attempting to start shock sequence without standoff connected. Press return to clear message and attach standoff to continue.

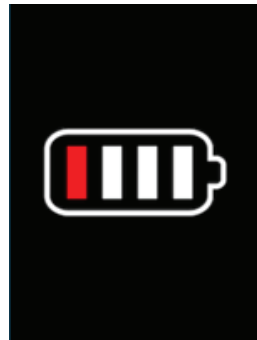

Low Battery A

Screen presented after power on or idle screen when battery reaches critically low level. Charge battery to remedy.

User Information:

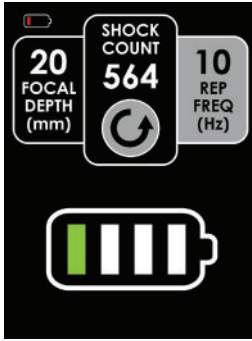

Low Battery B

Screen presented while shock is running and battery reaches critically low level. Handheld will power down after shock sequence completes. Charge battery to remedy.

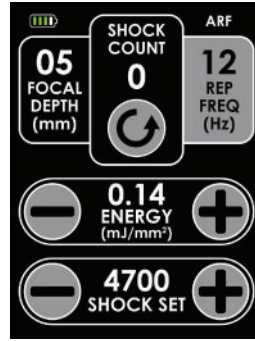

Adaptive Rep Frequency (ARF)

Under extreme conditions, such as extended use in a hot environment at the maximum "REP FREQ" and "ENERGY" settings, the CS Pro-VET may automatically reduce the shock wave repetition frequency. This ensures the device always delivers the "ENERGY" value shown on the display. When this occurs, an ARF will be shown at the top of the display, and the sound of shock wave generation will slow down slightly.

Error Codes:

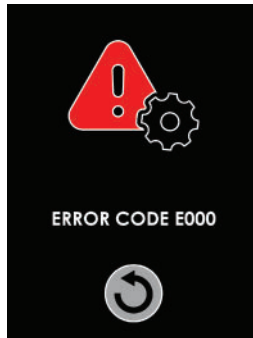

Error Code Warning

Screen presented if the device encounters an error code. Contact manufacturer for further instruction.

If you experience an error code, please stop using the device and contact the manufacture at: service@curative-sound.com

Cleaning the Device:

General hygienic cleaning of the device can be done simply with a disinfectant wipe. Do not submerge the device in water. Do not let ultrasound gel dry and harden on the device as it could affect the contact surface of the standoff. Always make sure that the standoff dust covers are installed on standoffs that are not being used to avoid accumulation of dust and debris on the oily surface. For sterile applications, the standoff can be sterilized using a low temperature system such as the Sterlink® Gas Plasma Sterilizer. Alternatively, the device can be wrapped in a sterile diagnostic ultrasound probe cover. Follow the manufacturers instructions.

LIMITED WARRANTY:

- During the one-year warranty period from the date of delivery of the product to the end customer, defects will be remedied at no charge to the customer upon the customer furnishing adequate proof that the defect is due to defects in material or workmanship. The warranty does not extend to wear parts such as the elastomeric standoff. Transport costs and the risk of loss during shipping shall be borne by the customer. Modifications to the device are not permitted. Any unauthorized opening, repair, or modification of the device by unauthorized personnel will relieve the manufacturer of its liability and responsibility for safe system operation. This will automatically void the warranty even before the end of the warranty period.
- Extended exposure to temperatures above 60° C or below -10° C will void the warranty. Submersion or over exposure to water will void the warranty. Do not leave the device in a hot vehicle for extended periods of time.
- Petroleum-based oil applied to the standoff will void the warranty.
- Warranty claims will only be accepted if the device is returned in its complete and original state, cleaned and in the case. Missing components will be replaced subject to charge. Accessories also sent will be checked and, if necessary, replaced after they have been assessed. The standoff is considered a wear part and is excluded from warranty claims.
- If warranty service work cannot be completed within 5 business days, a loaner unit will be provided, subject to service pool unit availability. If the device to be serviced is not under warranty, a loaner unit may be rented while repairs are being made.

- Should you have any further questions or require additional information, please feel free to contact your dealer or email the manufacturer at: **service@curative-sound.com**.

Product requiring service can be returned to:
Curative Sound, LLC.
Warranty & Service Department
11611 N. Meridian Street, Suite 425
Carmel, IN 46032 USA

- At your earliest convenience, please register your product on the Curative Sound website using the QR code shown below:

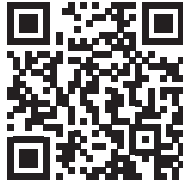

<https://curative-sound.com/support/>

SPECIFICATIONS:

CONTENTS

Focused Handheld Device	Wrist Strap
Standoffs (5 pcs)	Carrying Case
Li-ion batteries (2 pcs)	Shoulder Strap
Charger	Ultrasound Gel
Transducer Array Couplant Oil	

DIMENSIONS/WEIGHT

Handheld Device

8.0x3.0x1.8 (in) (20.3x7.6x4.45 cm)

14.4 oz. (0.41Kg)

Device in Case with Accessories

14.3x11.1x4.7 (in) (36.3x28.2x11.9cm)

8.2 lbs (3.7Kg)

OPERATION

Energy Flux Density Range (mJ/mm²): 0.02-0.22

Pulse Repetition Frequency (Hz): 2-12

Shock Wave Focal Depths (mm): 2, 5, 10, 20 and 30

Effective Focal Range (-6dB): 0-35mm

Effective Therapeutic Range (5MPa): 0-60mm

Sound Output During Use: 55dBA @0.5m

Battery Type: Rechargeable Lithium Ion

Battery Capacity: 2300mAh, 8.5Wh, 3.7V

Battery Life: >4 Hours

Battery Charge Time: 4 Hours

Reliability: > 5,000,000 Shock Waves Before Recalibration

Carrying Case: Water/Dust Proof, IPX7, Mil Spec Certified

Compliant to CISPR-11, Class B

SHOCK WAVE CHARACTERISTICS

(Measured Per the IEC 61846 Standard With the 30mm Standoff Installed)

Maximum Energy Flux Density	0.22 mJ/mm ²
Peak Positive Pressure	80 MPa
Peak Negative Pressure	-12 MPa
Rise Time (10-90%)	< 15 nS
Compressional Pulse Duration	100 nS
Fx-Therapeutic Width (5MPa)	14 mm
Fy-Orthogonal Therapeutic Width (5MPa)	24 mm
Fz-Therapeutic Extent (5MPa)	51 mm
Fx-Focal Width (-6dB)	1.20 mm
Fy-Orthogonal Focal Width (-6dB)	1.60 mm
Fz-Focal Extent (-6dB)	6.30 mm
Focal Volume	6.30 mm ³